

- **Switching point easily adjustable.**
- **High overpressure resistance and long working life even under harsh operating conditions.**
- **Type 0150 as a change-over switch and with the possibility for manifold mounting.**
- **Type 0151 as normally open or normally closed.**

#### 0150 / 0151 Technical data

Type:	0150	0151
Voltage:	max. 250 V	max. 42 V
Contact rating:	see table below*	≤ 4 A / 100 VA
Temperature stability:	-20 °C – +100 °C	-15 °C – +120 °C
Switching frequency:	200 / min.	
Mechanical life expectancy:	10 <sup>6</sup> cycles	
Pressure rise rate:	≤ 1 bar/ms	
Vibration resistance:	10 g / 5 – 200 Hz sine-wave	
Shock resistance:	294 m/s <sup>2</sup> ; 14 ms half-sine-wave	
Body material:	aluminium	brass
Degree of protection:	IP65 socket device fitted	IP65, terminals IP00
Weight in grams:	approx. 270 g	approx. 140 g

#### \*0150 Electrical values (for technical explanation see also page 9)

Rated operating voltage U <sub>e</sub> :	Rated operational current I <sub>e</sub> / Application category
250 Volt AC 50 / 60 Hz	5 Ampere / AC 12
250 Volt AC 50 / 60 Hz	1 Ampere / AC 14
24 Volt DC	3.5 / 3.5 Ampere / DC 12 / DC 13
50 Volt DC	2 / 1 Ampere / DC 12 / DC 13
75 Volt DC	1 / 0.5 Ampere / DC 12 / DC 13
125 Volt DC	0.3 / 0.2 Ampere / DC 12 / DC 13
250 Volt DC	0.25 / 0.2 Ampere / DC 12 / DC 13
Rated insulation voltage U <sub>i</sub> :	300 Volt
Rated operating current U <sub>imp</sub> :	2.5 kV
Rated thermal current I <sub>the</sub> :	6 Ampere
Switching overvoltage:	< 2.5 kV
Rated frequency:	DC and 50 / 60 Hz
Short circuit current rating of the device:	to 6.3 Ampere
Rated short-circuit current:	< 350 Ampere
Tightening torque of terminal screws:	< 0.35 Nm
Cable diameter:	0.5 – 1.5 mm <sup>2</sup>

**Comparison absolute pressure / relative pressure**

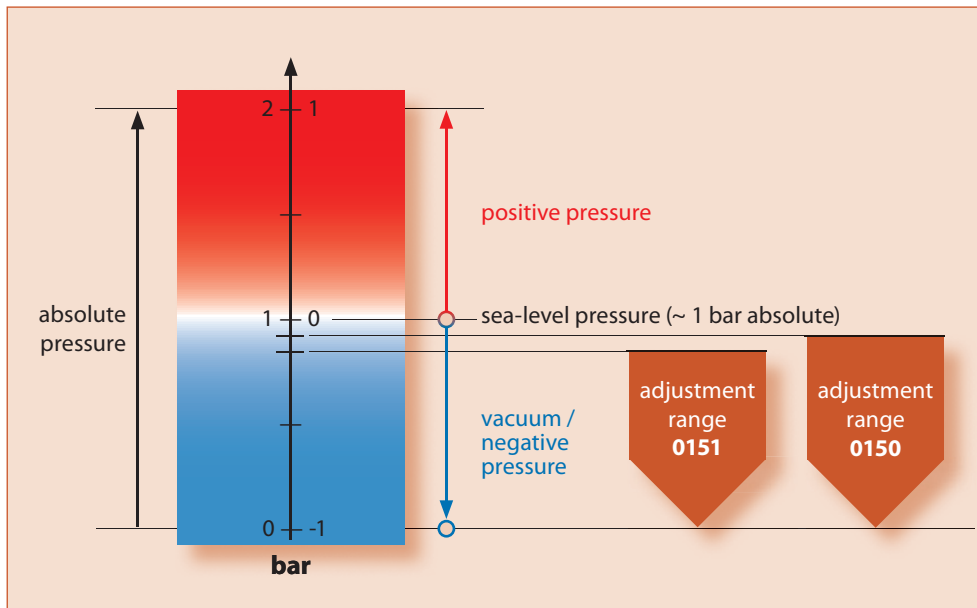

**Indication:** Desired switching points within the range of the vacuum have to be indicated relatively to the atmospheric pressure (normal pressure).

**Accessories**

 <p>60 Ø 28</p>	 <p>46 Ø 28</p>	
<p><b>Rubber protective cap</b> for series 0151</p> <p>with central cable feed for 1.5 – 5 mm cable diameter</p> <p><b>With fitted cap IP54</b></p> <p>Suitable for voltages up to 42 V</p>	<p><b>Rubber protective cap</b> for series 0151</p> <p>with two cable entries for 1.7 – 2.2 mm cable diameter</p> <p><b>With fitted cap IP54</b></p> <p>Suitable for voltages up to 42 V</p>	<p><b>Socket device with indicator light</b> for series 0150</p> <p>similar to DIN EN 175301-803-A (DIN 43650) Screw fixing Pg9 (cramping of cable to 6-9 mm)</p> <p><b>With fitted socket device IP65</b></p> <p>Suitable for 24 V or 250 V</p>
<p><b>Order number:</b></p>	<p><b>Order number:</b></p>	<p><b>Order number:</b></p>
<p><b>1-1-66-621-010</b></p>	<p><b>1-1-66-621-003</b></p>	<p><b>24 VDC: 1-1-61-652-021</b></p>
<p><b>250 VAC: 1-1-61-652-020</b></p>		



**CE marking**

SUCO vacuum switches rated with a voltage up to 250 V are covered by the Low Voltage Directive 73/23/EEC. An EC Declaration of Conformity has been issued for these vacuum switches and is on file at our offices. The corresponding switches bear the CE mark in our catalogue.

**Degree of protection IPXX**

The type approval does not apply without restriction to all environmental conditions. It is the responsibility of the user to check whether the electrical connection complies with regulations other than those stated and whether it can be used for special applications which could not be foreseen by us.

**Oxygen warning!**

When using oxygen, the relevant safety regulations must be observed. In addition, we recommend that a maximum operating pressure of 10 bar must not be exceeded.

# 0150

## Vacuum switch 250 V, with built-in changeover switch



- Aluminium body
- Max. voltage 250 V
- Overpressure safe up to 20 bar<sup>1)</sup>
- With socket device similar to DIN EN 175301 (DIN 43650)
- Hysteresis approx. 50 – 150 mbar (non-adjustable)

### With female thread

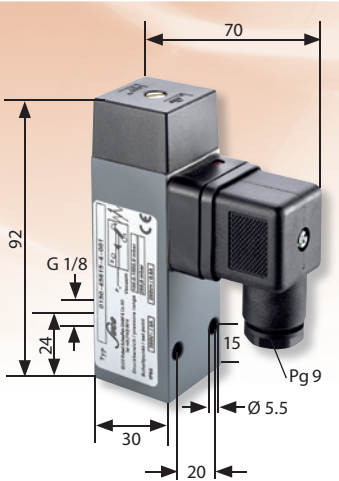

p <sub>max.</sub> in bar	Adjustment range in mbar (rel.)	Tolerance in mbar (at room temperature)	Thread	Order number:
--------------------------	---------------------------------	-----------------------------------------	--------	---------------

### 0150 Vacuum switch

20 <sup>1)</sup>	100 – 950	± 50	G 1/8 female	0150 456 15 4 001
------------------	-----------	------	--------------	-------------------

### Diaphragm material – areas of application

ECO	Air, oils, greases, fuels	4
-----	---------------------------	---

Temperature stability: -20 °C – +100 °C

<b>Order number:</b>	<b>0150 - 456 15 - 4 - 001</b>
----------------------	--------------------------------

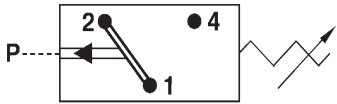

■ Our pressure switches are also available with factory preset switching points.

■ For further technical data and accessories see page 50/51.

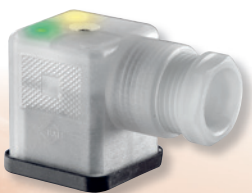
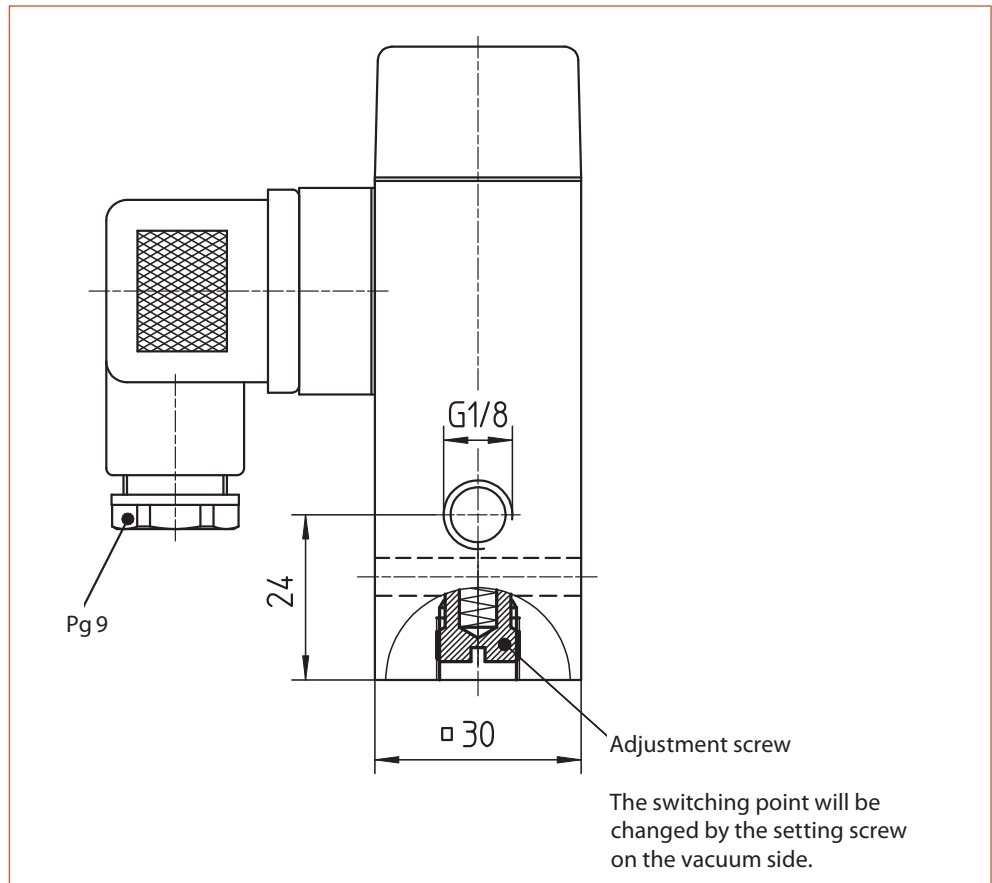

<sup>1)</sup> Static pressure, dynamic pressures should be 30 to 50% lower. These values refer to the hydraulic or pneumatic part of the pressure switch.

# 0151

## Vacuum switch 42 V, normally open or normally closed

- Brass body
- With M3 screw or spade terminals
- Max. voltage 42 V
- Overpressure safe up to 35 bar<sup>1)</sup>



p <sub>max.</sub> in bar	Adjustment range in mbar (rel.)	Tolerance in mbar (at room temperature)	Thread	Order number:
-----------------------------	---------------------------------------	--------------------------------------------	--------	---------------

### 0151 Vacuum switch with screw terminals, normally open (no) → |:

35 <sup>1)</sup>	200 – 950	± 100	G 1/8 female	0151	452	15	3	001
------------------	-----------	-------	--------------	------	-----	----	---	-----

### 0151 Vacuum switch with M3 screw terminals, normally closed (nc) → :|

35 <sup>1)</sup>	200 – 950	± 100	G 1/8 female	0151	453	15	3	001
------------------	-----------	-------	--------------	------	-----	----	---	-----

### 0151 Vacuum switch with spade terminals, normally open (no) → |:

35 <sup>1)</sup>	200 – 950	± 100	G 1/8 female	0151	454	15	3	001
------------------	-----------	-------	--------------	------	-----	----	---	-----

### 0151 Vacuum switch with spade terminals, normally closed (nc) → :|

35 <sup>1)</sup>	200 – 950	± 100	G 1/8 female	0151	455	15	3	001
------------------	-----------	-------	--------------	------	-----	----	---	-----

### Diaphragm material – areas of application

FKM	Air, oils, greases, fuels	3
-----	---------------------------	---

Temperature range: - 15 °C – + 120 °C



Order number:	0151 – XXX 15 – 3 – 001
---------------	-------------------------

### With female thread

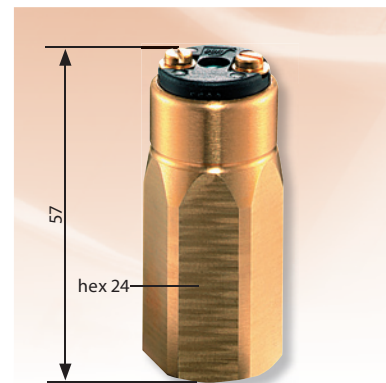

### With female thread

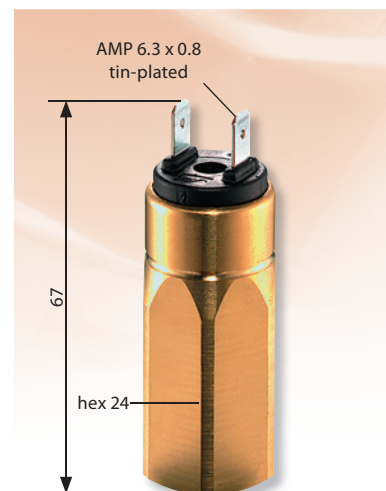

■ Our pressure switches are also available with factory preset switching points.

■ For further technical data and accessories see page 50/51.



<sup>1)</sup> Static pressure, dynamic pressures should be 30 to 50% lower. These values refer to the hydraulic or pneumatic part of the pressure switch.